

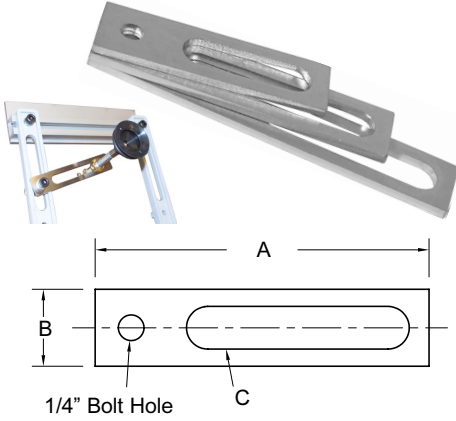

# END OF ARM TOOLING PARTS FOR ROBOTIC SPRUE PICKERS



## STEM EXTENSIONS

Part No.	A	B	C (fitting size)	PRICE
TOP21111	2-1/2"	3/4"	10mm	\$3.95
TOP21112	3-1/4"	3/4"	10mm	4.95
TOP21113	4"	3/4"	10mm	5.50
TOP21114	2-1/2"	1"	12mm	4.23
TOP21115	3-1/4"	1"	12mm	5.26
TOP21116	4"	1"	12mm	5.86

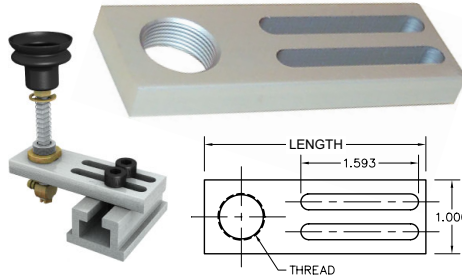

## Slotted Brackets

PART NO.	THREAD	LENGTH	PRICE
TOP21118-10	10mm	3" (76.2mm)	\$9.50
TOP21118-12	12mm		9.50
TOP21118-16	16mm		9.50
TOP21118-20	20mm		9.50
TOP21118-B	Blank		6.90
TOP21119-10	10mm	4" (101.6mm)	\$9.90
TOP21119-12	12mm		9.90
TOP21119-16	16mm		9.90
TOP21119-20	20mm		9.90
TOP21119-B	Blank		7.30
TOP21120-10	10mm	5" (127mm)	\$10.30
TOP21120-12	12mm		10.30
TOP21120-16	16mm		10.30
TOP21120-20	20mm		10.30
TOP21120-B	Blank		7.75

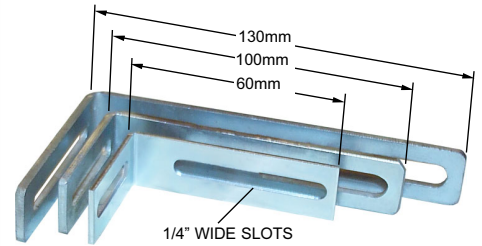

## L Brackets

60mm L Bracket	
<b>TOP21100</b> .....	\$3.09
100mm L Bracket	
<b>TOP21200</b> .....	\$3.95
130mm L Bracket	
<b>TOP21300</b> .....	\$9.95



# ALUMINUM VACUUM MANIFOLD - EOAT

**A BETTER SOLUTION FOR  
QUICK CHANGE END OF ARM TOOLING**

Made from lightweight aluminum these vacuum manifolds are ideal for end of arm tooling. Instead of using a \$600 Quick changer setup with multiple vacuum connections these manifolds allow you to run a single vacuum line to the End of Arm Tooling frame then branch off to all your suction devices. This allows for a single line to be disconnected to facilitate quick tooling changes without the expense or the weight of a expensive changing chuck.

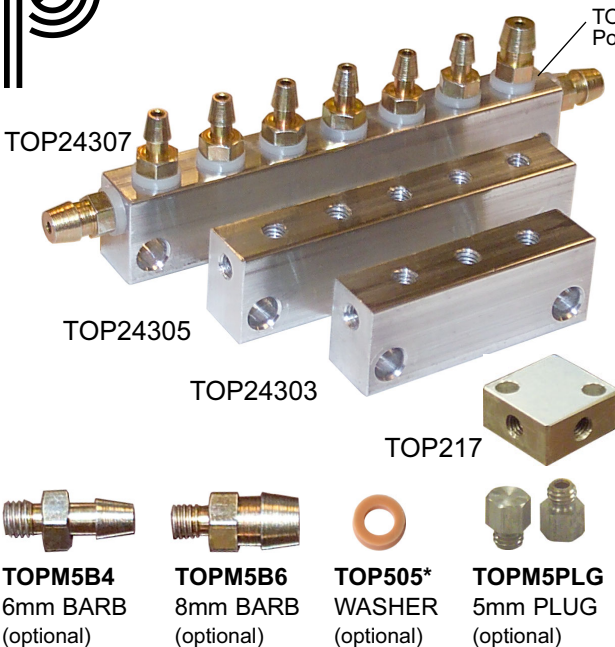

PART NO	DESCRIPTION	WT (g)	PRICE
TOP217	3 OUTLET / 1 INLET MANIFOLD	7g	\$3.25
TOP24303	5 OUTLET / 1 INLET MANIFOLD	28g	\$11.15
TOP24305	7 OUTLET / 1 INLET MANIFOLD	44g	\$12.65
TOP24307	9 OUTLET / 1 INLET MANIFOLD	59g	\$13.60
TOPM5B4	6mm TUBING BARB (5mm THD)	2.6g	\$1.91
TOPM5B6	8mm TUBING BARB (5mm THD)	4.2g	\$3.84
* TOP505	PLASTIC WASHERS (bag of 25 pcs)	.09g ea.	\$7.90
TOP31013W	NYLON WASHERS 24 PACK		\$9.23
TOPM5PLG	STEEL PLUG	1.5g	\$1.25

\* O.D. .305 x I.D. .177 x .060 Thick

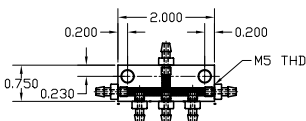

TOP24303

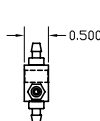

TOP24305

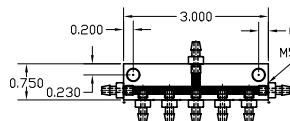

TOP24307



## PLASTIC PROCESS EQUIPMENT, INC.

www.ppe.com • e-mail: sales@ppe.com

**PPE WEST** 6385 Montessouri Street, Las Vegas, Nevada 89113  
702-433-6385 • 800-258-8877 • Fax: 702-433-6388

**PPE SOUTH** 11218 Challenger Avenue, Odessa, Florida 33556  
727-834-8888 • 800-282-6783 • Fax: 727-834-8873

8303 CORPORATE PARK DRIVE, MACEDONIA (Cleveland), OHIO 44056, USA

216-367-7000 • Toll Free: 800-321-0562 • Fax: 216-367-7022 • Order Fax: 800-223-8305

Toll Free: USA, Canada & Mexico  
**800-362-0706**