



THERMOCOUPLE EXTENSIONS

AVAILABLE IN BOTH TYPE J OR TYPE K!

STAINLESS STEEL ARMOR

STAINLESS STEEL ARMOR TYPE J OR TYPE K

MALE PLUG - STAINLESS STEEL ARMOR

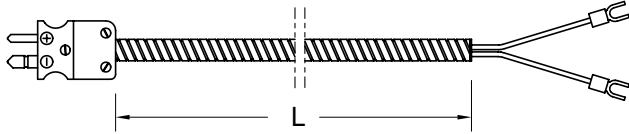

FEMALE PLUG - STAINLESS STEEL ARMOR

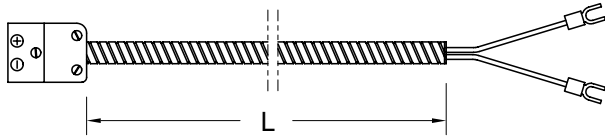

MALE PLUG - STAINLESS STEEL ARMOR - MALE PLUG

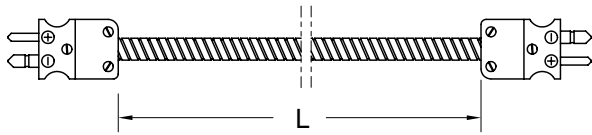

MALE PLUG - STAINLESS STEEL ARMOR - FEMALE PLUG

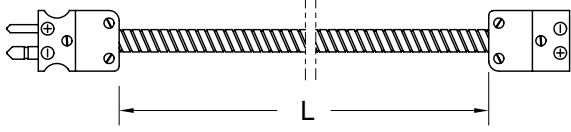

FEMALE PLUG - STAINLESS STEEL ARMOR - FEMALE PLUG

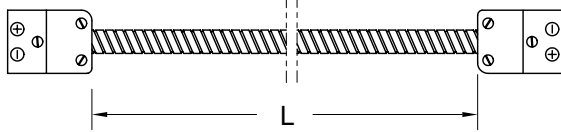

PART NO.	TYPE	L DIM LENGTH	PRICES	
			1-9	10+
AEM-48	J	48"	\$11.75	\$11.40
AEMK-48	K	48"	\$13.85	\$13.45
AEM-72	J	72"	\$13.95	\$13.50
AEMK-72	K	72"	\$16.75	\$16.20
AEM-120	J	120"	\$18.30	\$17.75
AEMK-120	K	120"	\$22.45	\$21.75
AEF-48	J	48"	\$16.80	\$11.40
AEFK-48	K	48"	\$13.85	\$13.45
AEF-72	J	72"	\$13.95	\$13.50
AEFK-72	K	72"	\$16.75	\$16.20
AEF-120	J	120"	\$18.30	\$17.75
AEFK-120	K	120"	\$22.45	\$21.75
AEMM-48	J	48"	\$16.80	\$16.25
AEMMK-48	K	48"	\$19.30	\$18.70
AEMM-72	J	72"	\$19.00	\$18.35
AEMMK-72	K	72"	\$22.25	\$21.50
AEMM-120	J	120"	\$23.35	\$22.60
AEMMK-120	K	120"	\$27.95	\$27.10
AEMF-48	J	48"	\$16.80	\$16.25
AEMFK-48	K	48"	\$19.30	\$18.70
AEMF-72	J	72"	\$19.00	\$18.35
AEMFK-72	K	72"	\$22.25	\$21.50
AEMF-120	J	120"	\$23.35	\$22.60
AEMFK-120	K	120"	\$27.95	\$27.10
AEFF-48	J	48"	\$16.80	\$16.25
AEFFK-48	K	48"	\$19.30	\$18.70
AEFF-72	J	72"	\$19.00	\$18.35
AEFFK-72	K	72"	\$22.25	\$21.50
AEFF-120	J	120"	\$23.35	\$22.60
AEFFK-120	K	120"	\$27.95	\$27.10

MIX OR MATCH ALL MODELS OF THERMOCOUPLES FOR PRICE BREAKS.



PLASTIC PROCESS EQUIPMENT, INC.

www.ppe.com • e-mail: sales@ppe.com

PPE WEST 6385 Montessouri Street, Las Vegas, Nevada 89113
702-433-6385 • 800-258-8877 • Fax: 702-433-6388

PPE SOUTH 11218 Challenger Avenue, Odessa, Florida 33556
727-834-8888 • 800-282-6783 • Fax: 727-834-8873

8303 CORPORATE PARK DRIVE, MACEDONIA (Cleveland), OHIO 44056, USA

Toll Free: USA, Canada & Mexico

216-367-7000 • Toll Free: 800-321-0562 • Fax: 216-367-7022 • Order Fax: 800-223-8305

800-362-0706