



AUTOMATIC CURRENT INDICATORS

FOR CONTINUOUS INDICATION OF CURRENT FLOW

TWO TYPES AVAILABLE

1. CURRENT RING WITH BUILT-IN LED } **RED OR GREEN**
 2. CURRENT RING WITH REMOTE LED }

FEATURES:

- Small, compact
- Economical
- Reliable
- High sensitivity
- No additional wiring
- Easy to install
- Rugged
- Negligible power consumption

**INDICATES
HEATER FAILURE
IMMEDIATELY**

SPECIFICATIONS:

- Totally encapsulated
- Outside diameter: .95 inch
- Thickness: .46 inch
- Maximum number of insulated wires allowed through opening:
 - One pass: 6 AWG
 - Two passes: 10AWG
 - Three passes: 12 AWG
 - Four passes: 18 AWG
- Minimum watts needed for power:

	120V	240V
One pass - Red LED 2A	240W	480W
Green LED 2.5A	300W	600W
Two passes - Red LED 1A	120W	240W
Green LED 1.25A	150W	300W
Three passes - Red LED .66A	60W	120W
Green LED .83A	75W	150W
- Illumination is visible up to 60 degrees from center axis of LED
- Storage temperature: -55°C to +100°C
- Operating temperature: -55°C to +80°C
- Color: CR516 - Yellow
CR516WL - Black

ELECTRICAL CHARACTERISTICS:

- Operates at any voltage, 50-60Hz
- Completely insulated
- Totally self-contained, requires no electrical connection
- Sensitivity in proportion to the number of wire passes through opening
- Maximum current: 100 Ampere

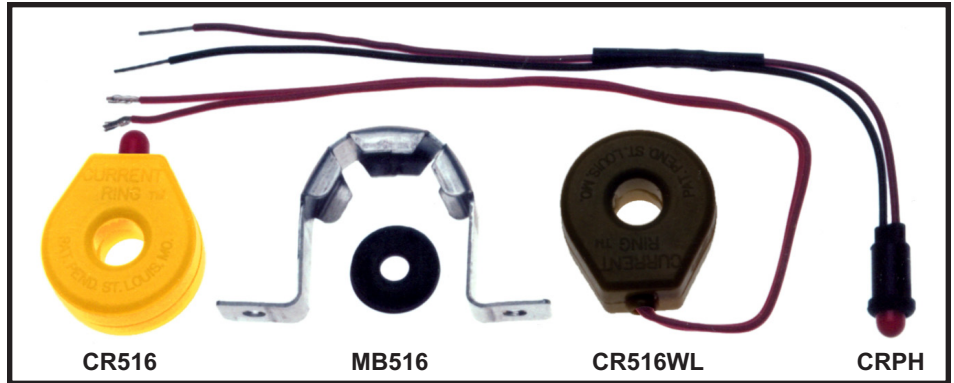

TYPICAL APPLICATIONS:

- Load sensing
- Detect power loss
- Indicate phase loss
- Detect heater current
- Sense ground fault
- Detect motor operation
- Indicate open fuses

CONSTRUCTION:

CURRENT RING™ is a proprietary design current transformer with an integrally mounted LED.

The current transformer is specially designed to provide maximum secondary voltage at low primary current levels. The core is designed with special saturation characteristics to limit its output voltage at high primary currents. The output of the current transformer is further attenuated with an attached zener diode and resistor.

The LED is a high efficiency device to provide maximum light output at low input currents.

The entire unit is encapsulated in a hard plastic housing.

CURRENT RING™ is a small, self-contained device used for indicating electrical current flow. This device provides a safe, economical and efficient way to indicate the presence (or absence) of electrical current flow. A current-carrying wire is passed through the opening in the center of the device. When current in the wire reaches above the minimum operating level the Light Emitting Diode (LED) extending from the device begins to illuminate.

A typical application would be in troubleshooting an electrical control panel. The device would be attached to specific wires in a control panel. Simply noticing whether the device was illuminated would provide an immediate indication of the electrical status of the wire.

Another application would be in a process heating system with electrical heaters wired in parallel. Wires from each heating element would be routed through the opening in the device. The device would then show immediately which element was in operation and which was open.

The device is supported by the current carrying wire and, if necessary, may be secured in place with a Nylon tie.

— PRICES —

BUILT-IN		REMOTE	
CR516 Current Ring (Red LED)		CR516WL Current Ring	
1-11 Pcs.	\$12.10	1-11 Pcs.	\$9.85
12+ Pcs.	\$11.50	12+ Pcs.	\$9.35
CR516G Current Ring (Green LED)		CRPH LED (Red)	
1-11 Pcs.	\$15.00	CRPHG LED (Green)	\$5.80
12+ Pcs.	\$14.30	PH31 Splash Proof LED (Red)	\$6.99
MB516 Panel Mounting Bracket	\$2.15 ea.	PH31G Splash Proof LED (Green)	\$7.70
			\$9.35



PLASTIC PROCESS EQUIPMENT, INC.

www.ppe.com • e-mail: sales@ppe.com

6385 Montessouri Street, Las Vegas, Nevada 89113
 702-433-6385 • 800-258-8877 • Fax: 702-433-6388

11218 Challenger Avenue, Odessa, Florida 33556
 727-834-8888 • 800-282-6783 • Fax: 727-834-8873

8303 CORPORATE PARK DRIVE, MACEDONIA (Cleveland), OHIO 44056, USA

216-367-7000 • Toll Free: 800-321-0562 • Fax: 216-367-7022 • Order Fax: 800-223-8305

Toll Free: USA, Canada & Mexico
800-362-0706