



ABSORBENT MATERIALS

Spilfyter®

SPILL CONTROL PRODUCTS

Cellulose Based Sorbents

Retains over **31% MORE**
*BASED ON INDEPENDENT LABORATORY TESTS

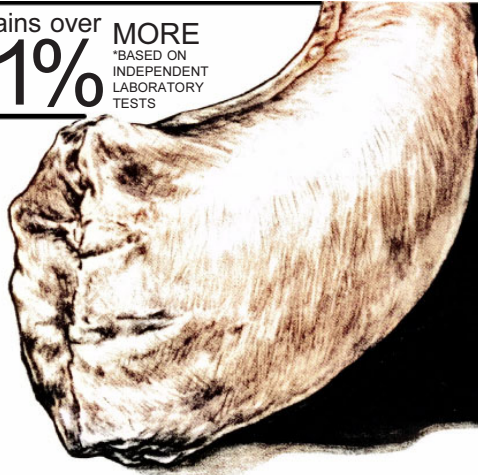

- ABSORPTION SAFETY IN DIKES, PILLOWS, PADS, OR ROLLS
- ORGANIC CELLULOSE FIBERS IN POLYPROPYLENE COVER WON'T DUST
- ABSORBS 20% MORE
- ABSORBS LIQUIDS
- EASY TO DISPOSE OF - CAUSES NO POLLUTION OF ITS OWN
- MOLDS TO ANY SHAPE - STAYS PUT
- CUT LABOR COSTS - REDUCES PLANT CONTAMINATION

OIL RETENTION 5W-30 FOR 46" (3.83') DIKES

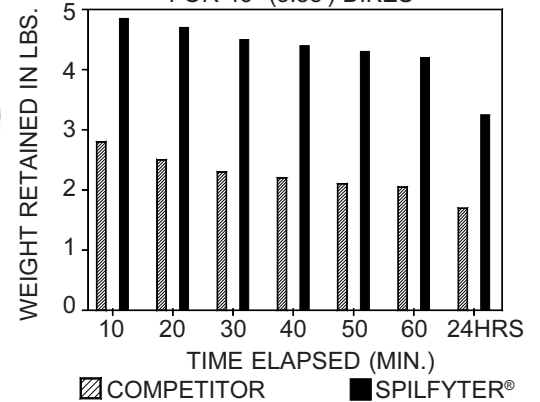

DIKES - SOCKS



DIKES - SOCKS

SPILFYTER® Dikes-Socks are ideal for soaking up non-aggressive fluids, oils, and other petroleum products. Their moldable shape easily conforms to fit around equipment, drums, tanks, sinks, or walkways. They are pure cellulose fibers in a propylene cover. No Dust!

PILLOWS

SPILFYTER® Pillows are the easy to handle solution to the cleanup of oil spills on land or water. Pillows are highly absorbent, picking up many times their weight in oil. SPILFYTER® Pillows are designed for quick and economical cleanup of all non-aggressive liquid leaks and spills.



PILLOWS

PADS

SPILFYTER® Pads are perfect for soaking up oils around or under leaking machinery or for cleaning up oily tools. Pads absorb many times their own weight in petroleum products and may be used on oils, hydrocarbons, organic solvents, and a variety of hazardous liquids.



PADS

ROLLS

Use SPILFYTER® Rolls on all sizes of oily spills and non-aggressive liquid discharges. Rolls can be cut to cover small areas such as under leaking machinery.



ROLLS

BEWARE OF WILD WACKY CLAIMS BY COMPETING OIL SUCKING LIARS. OUR SPILFYTERS WERE SO SUPERIOR THEY DROPPED THEIR BRAND AND CHANGED TO OURS! OURS ARE THE BEST!



PLASTIC PROCESS EQUIPMENT, INC.

8303 CORPORATE PARK DRIVE
MACEDONIA, OHIO 44056
216-367-7000 • FAX: 216-367-7022
TOLL FREE: 800-321-0562

6385 MONTESSOURI STREET
LAS VEGAS, NEVADA 89113
702-433-6385 • FAX: 702-433-6388
TOLL FREE: 800-258-8877

www.ppe.com
e-mail: sales@ppe.com

Toll Free: USA, Canada & Mexico
800-362-0706

Order Fax: 800-223-8305