

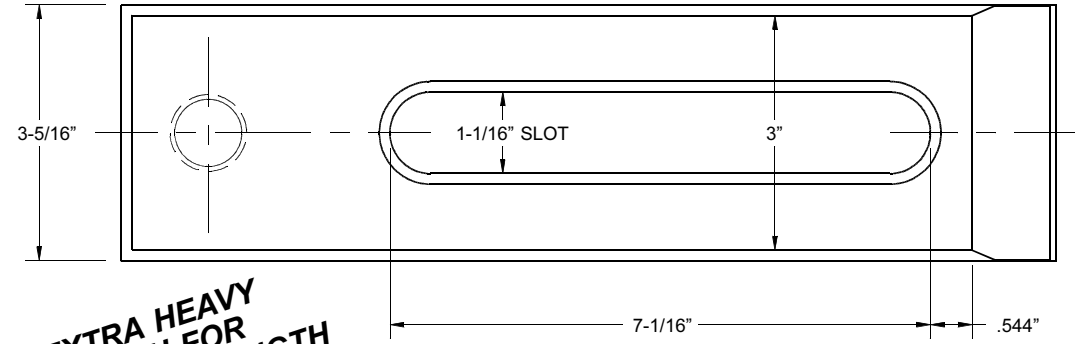

12" HEAVY DUTY FORGED

**MOLD
CLAMPS**

**FOR 1"-8 THD. PLATEN HOLES (or 24mm)
FORGED & HEAT TREATED**



**EXTRA HEAVY
WIDTH FOR
GREATER STRENGTH**

**FOR
1"-8 BOLTS**
**CLOSED TOE
FOR
MORE
STRENGTH**

**APPROX.
CLAMP
WEIGHT
14 LBS.**

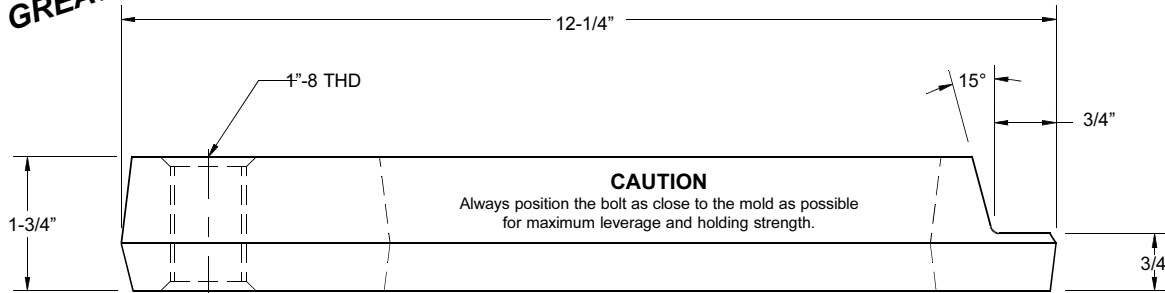

CAUTION
Always position the bolt as close to the mold as possible
for maximum leverage and holding strength.

MODEL FCM-12 MOLD CLAMP

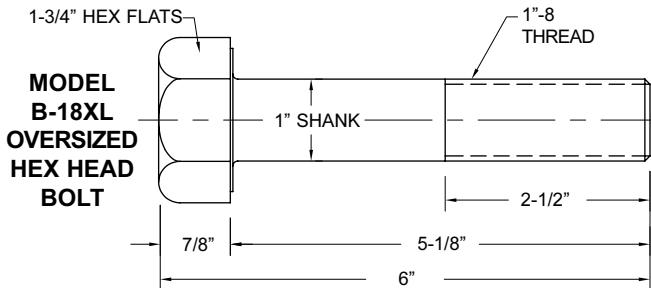

**MODEL
B-18XL
OVERSIZED
HEX HEAD
BOLT**

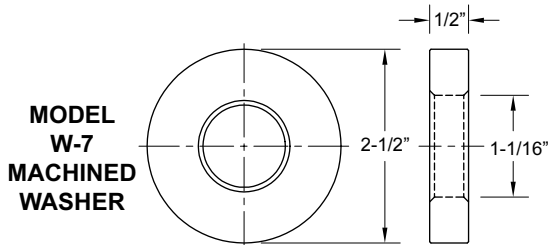

**MODEL
W-7
MACHINED
WASHER**

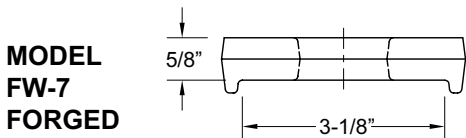

**MODEL
FW-7
FORGED
NO-TURN
WASHER**

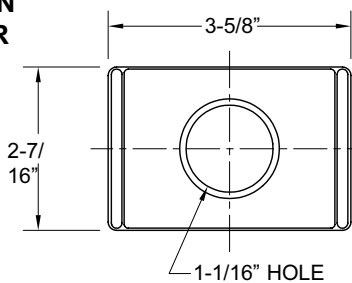

PART NO.	DESCRIPTION	QUANTITY PRICING		
		1-8	9-23	24+
FCM-12	12" Forged Mold Clamp	\$50.75	\$48.75	\$46.50
B-18XL	1"-8 Heavy Duty Bolt	14.10	13.75	13.30
G8010850	1"-8 Grade 8 Bolt	4.23	4.23	4.05
AB-2	1"-8 Adjustment Bolt	7.30	6.95	6.60
SAB1	1"-8 Swivel Bolt	9.75	9.25	8.80
W-7	Washer 1-1/16" ID	5.10	4.90	4.70
FW-7	No-Turn Washer 1-1/16" ID	6.00	5.70	5.40

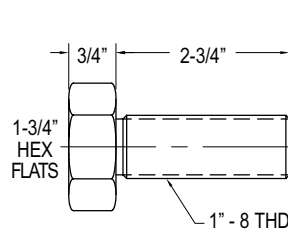

**MODEL AB-2 HEEL
ADJUSTMENT BOLT**

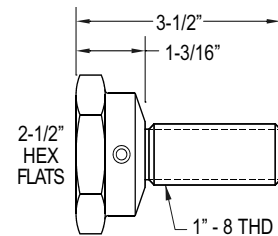

**MODEL SAB1 SWIVEL
HEEL ADJUSTMENT BOLT**

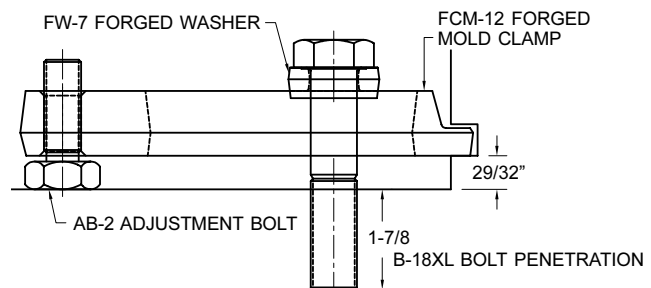

FOR 29/32" TO 2" MOLD FLANGES