



AIR OPERATED GATE CUTTERS

STANDARD DUTY MODELS - CUTS TOUGH PLASTICS

REDUCE OPERATOR FATIGUE

ALL TOOLS

Standard actuators have a piston-stroke of 1-1/2 inches (38mm) and deliver rated thrust at 80 psi (5.62 kg/cm²) air input. Units will give positive operation, with proportionally lower thrust, at inputs down to 60 psi (4.22 kg/cm²). Unit can be operated at air pressures of 60 to 100 psi (4.22 to 7.03 kg/cm²).

2400 LB. CUTTING PRESSURE

ALL CUTTING PRESSURES CALCULATED MIDWAY ON CUTTING BLADE @ 80 P.S.I.

9 7/8" LENGTH O.A. with Blades.
Wt. 2 lbs. 13 ounces.

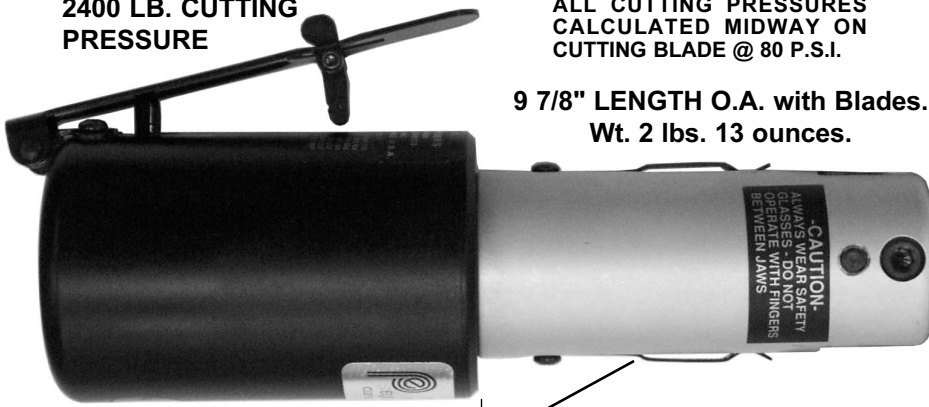

2-1/2" BODY DIA.

#3-41K2 LEAF SPRINGS .. \$14.45 pr

Model SA-2 Blade Holder Assy. Only

MODEL SP-004/PGC-4

STANDARD HAND-HELD Power Pack with Blade Holder, 5' Hose and Fittings (Blades not included)

1 Unit \$560.80
2 or more \$539.25

MODEL SP-004F/PGC-4

FOOT SWITCH TYPE with Blade Holder, Two 5 ft. Hoses and Fittings (Blades & Foot Switch not included)

1 Unit \$576.00
2 or more \$568.45

ALL BLADES

AISI-SI Tool Steel. They can be removed for sharpening and can be reversed for left hand operation

SA-2 Blade Holder Assembly

1 or more \$113.70



RPGC-4

Blade Opening
.625" at Tip
.313" at Base
.875" Cutting Length
25° Angle

Model **RPGC-4** Blades
1 Set \$137.15
2 or more \$130.60



HH-003

Blade Opening
.531" at Tip
.469" at Base
.438" Cutting Length
60° Angle

Model **HH-003** Blades
1 Set \$481.90
2 or more \$462.10

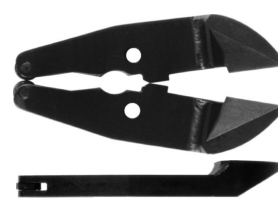

A3X-77

Blade Opening
.750" at Tip
.440" at Base
1.200" Cutting Length
25° Angle

Model **A3X-77** Blades
1 Set \$249.85
2 or more \$239.60

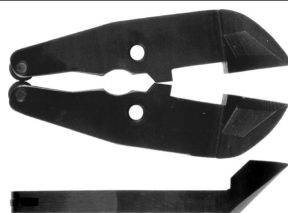

A3X-45

Blade Opening
.550" at Tip
.380" at Base
.800" Cutting Length
45° Angle

Model **A3X-45** Blades
1 Set \$249.85
2 or more \$239.60

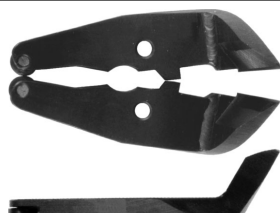

A3X-60

Blade Opening
.500" at Tip
.375" at Base
.900" Cutting Length
60° Angle

Model **A3X-60** Blades
1 Set \$249.85
2 or more \$239.60

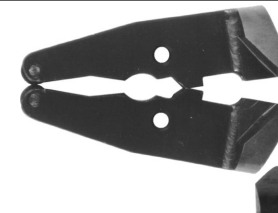

A3X-90

Blade Opening
.375" at Tip
.375" at Base
.800" Cutting Length
90° Angle

Model **A3X-90** Blades
1 Set \$249.85
2 or more \$239.60

MODEL 105 FOOT SWITCH
\$156.15



MODEL A-202-4 BENCH STAND AND CLAMP
\$99.45



MODEL DA-1 SAFETY LEVER
\$36.50



PLASTIC PROCESS EQUIPMENT, INC.

www.ppe.com • e-mail: sales@ppe.com

PPE WEST 6385 Montessouri Street, Las Vegas, Nevada 89113
702-433-6385 • 800-258-8877 • Fax: 702-433-6388

PPE SOUTH 11218 Challenger Avenue, Odessa, Florida 33556
727-834-8888 • 800-282-6783 • Fax: 727-834-8873

8303 CORPORATE PARK DRIVE, MACEDONIA (Cleveland), OHIO 44056, USA

216-367-7000 • Toll Free: 800-321-0562 • Fax: 216-367-7022 • Order Fax: 800-223-8305

Toll Free: USA, Canada & Mexico
800-362-0706