

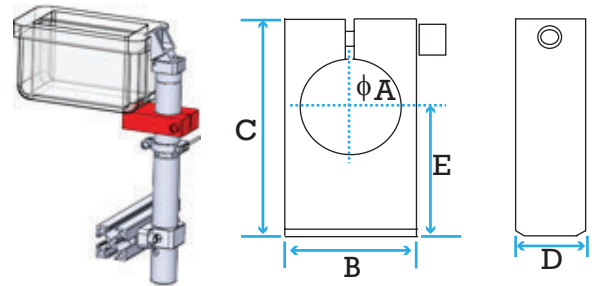

Finger Gripper Guides, Gripper Extension Tube, Finger Sensor Bracket

FGF Finger Guides

Part#	A	B	C	D	E	Wt.	Mounting Gripper Finger	Price
FGF14	14	22	42	10	26	12g	FG-1435/1490/1495	\$13.27
FGF20	20	32	50	14	31	25g	FG-2035/2090/2095	\$15.92



FGS Finger Guides

Part#	A	B	C	D	E	F	G	Wt.	Mounting Gripper Finger	Price
FGS14	14	19	31	23	15	13	5.5	9g	FG-1435/1490/1495	\$13.27
FGS20	20	26	35	25	16	15	5.5	13g	FG-2035/2090/2095	\$16.81

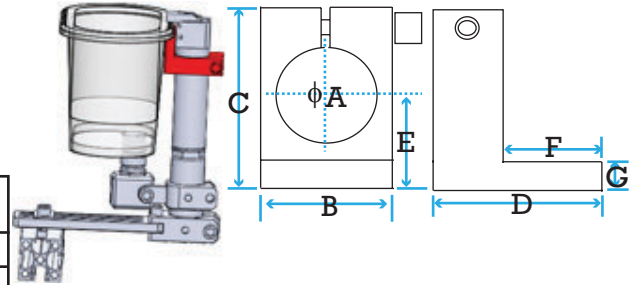
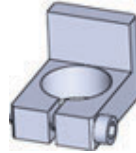

* FGS Finger Guide is typically adopted by FG-2090/1490 for gripping part edge.

GFG Finger Guides

Part#	A	B	C	D	E	Wt.	Mounting Gripper Finger	Price
GFG14	14	26	25	33	12	12g	FG-1435/1490/1495	\$15.48
GFG20	20	35	30	37	14	19g	FG-2035/2090/2095/2095P	\$17.69

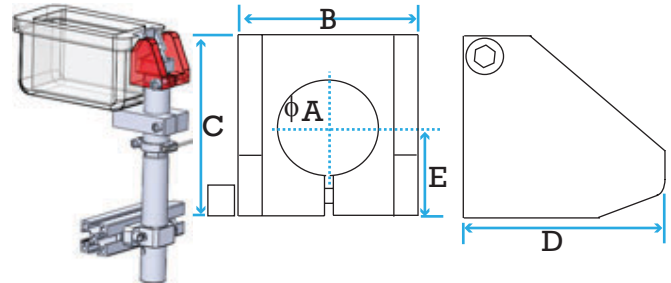
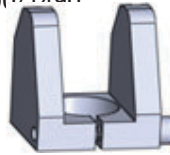

ET Gripper Extension Tubes

Part#	A	B	C	Wt.	Mounting Gripper Fingers Sprue Grippers/Spensions	Price
ET14L40	14	40	M12x1	6g	FG-1435/1490/1495	\$7.08
ET14L80	14	80	M12x1	14g	FG-1435/1490/1495	\$8.85
ET20L50	20	50	M17x1	15g	FG-2035/2090/2095/2095P SG-20-A	\$8.85
ET20L100	20	100	M17x1	29g	FG-2035/2090/2095/2095P SG-20-A	\$9.73

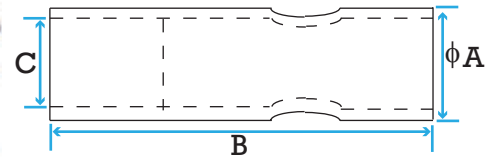
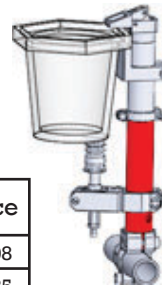
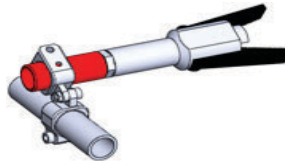

FSB Finger Sensor Bracket

Part#	A	B	C	D	E	Wt.	Mounting Gripper Finger	Price
FSB-14	14	15	18	28	7	23g	FG-1435/1490/1495	\$31.85
FSB-20	20	15	24	34	7	26g	FG-2035/2090/2095/2095P	\$46.00

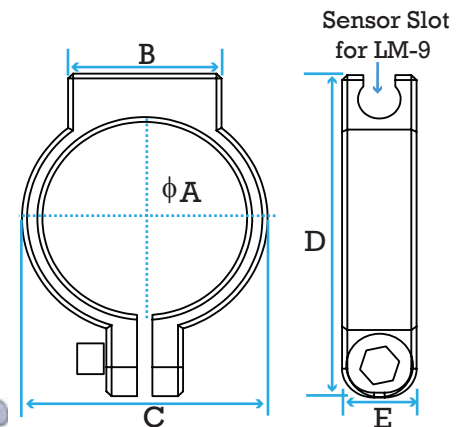
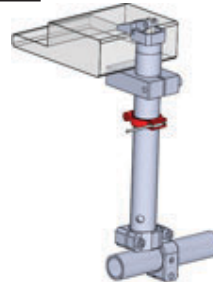

Sensor-Slot drawing

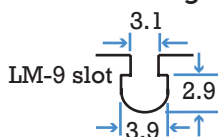

Optional Sensor Type - 6-24 Volts DC

Part#	Description	Price
LM-9N	NPN sensor 3-wire Hall effect with 2m leads	\$31.85
LM-9NM	NPN sensor 3-wire Hall effect with M8 connector	\$32.73
LM-9P	PNP sensor 3-wire Hall effect with 2m leads	\$33.62
LM-9PM	PNP sensor 3-wire Hall effect with M8 connector	\$34.50

LM-9 series sensor

